



At the heart of your home

GAS FIRES 2015-2016





At the heart of your home

# Welcome to Flavel



**BFM Europe**  
BRITISH FIRE MANUFACTURERS

Today BFM Europe is the fastest growing domestic fire producer in the country with an unequalled reputation for quality and service. Every Flavel branded gas fire is developed and manufactured in Britain at our purpose built, state-of-the-art facility in Stoke-on-Trent.



See page 7 for details about our 7 year guarantee



At Flavel we know how important it is to create a stylish and relaxing living environment. That's why we've developed this collection of affordable gas fires to complement all tastes and lifestyles. I believe our success stems from a combination of innovative design, investment in technology and the highest quality manufacturing standards. As a result all Flavel gas fires carry a 7 year guarantee to reflect my belief in their quality and durability. This brochure has been designed to make the purchase of your new Flavel gas fire as simple as possible. I hope you will find it both informative and inspiring.

## bsi. Product Testing & Certification

All our gas fires are independently tested, approved and verified by the British Standards Institution (BSI).

The BSI is an independent organisation. They are not owned by the government, industry or shareholders, which means that they can be totally objective with regards testing and certification. This gives their assessments more authority than those of an organization that has a vested interest in promoting its members.

They have some of the most experienced and knowledgeable staff in the world and are recognised internationally for their technical expertise, quality services and in-depth knowledge of gas, electrical, oil and solid fuel product testing and certification.

The wide-ranging capability of their testing facilities and the broad expertise and knowledge of their testing and certification staff ensures our products are rigorously tested with the utmost integrity.

## Contents

### Hole in the Wall & Wall Mounted fires



Castelle Slimline Page 9

Castelle Slimline .....	9
Finesse .....	10
Windsor Wall.....	11
Curve.....	12
Kamina .....	13
Expression HE.....	14
Diamond HE.....	15
Rocco HE & Rocco Balanced Flue.....	16
Jazz HE & Jazz Balanced Flue.....	17

### Full Depth Hearth Mounted Fires



Linear coal Page 33

Waverley .....	29
Calypso & Calypso Plus .....	30
Rhapsody & Rhapsody Plus.....	31
Kenilworth, Kenilworth Plus, HE & Powerflue.....	32
Linear, Linear Plus, HE & Powerflue.....	33
Caress, Caress Plus & Caress HE.....	34
Richmond & Richmond Plus.....	35
Decadence Plus & Decadence HE.....	36
Opulence Plus .....	37
Expression Plus .....	38
Sophia Suite.....	39
Calibre BF .....	40

An introduction to High Efficiency Gas Fires .....	4
Guide to icons.....	6

### Slimline Hearth Mounted Fires



Windsor Traditional Page 19

Windsor Contemporary.....	18
Windsor Traditional & Windsor Classic.....	19
Melody.....	20
Warwick .....	21
Stirling Plus.....	22
Caress Slimline .....	23
Decadence HE Slimline .....	24
Raglan Balanced Flue.....	25
Orchestra Balanced Flue.....	26
Atlanta Balanced Flue .....	27

### Outsets & Freestanding Fires



Renaissance Page 48

Emberglow & Emberglow Balanced Flue.....	41
Renoir .....	42
Regent LFE.....	43
Regent.....	44
Welcome.....	45
Strata .....	46
Misermatic.....	47
Renaissance.....	48
Firenza.....	49
Thurcroft Stove.....	50

Builders' Opening Sizes .....	51
-------------------------------	----



# high efficiency

Flavel has always had a reputation as a manufacturer of some of the most efficient fires on the market. Now we have set new industry standards with the introduction of the Flavel HE high efficiency range: exceptional heat output combined with lower running costs compared to standard gas fires.

Flavel's R&D team has invested in developing the technology to meet the key objective of producing gas fires that save energy and as a result, help to keep costs down.

Get up to  
**94%**  
net efficiency  
from your gas fire...

## Open Fronted Plus

Open fronted HE fires provide the look and feel of a real open fire with net efficiencies of up to 74%. This type of fire provides both radiant and convected heat. Radiant heat is emitted from the coal or pebble fuel effect and the convected heat is generated by cool air drawn into the base of the fire which passes through a heat exchanger and is then emitted as warm air through the gap above the canopy.

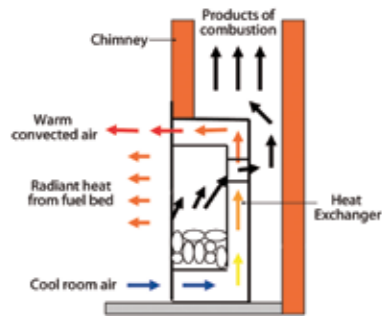

74% net efficiency



Richmond Plus in brass page 35

## Glass Fronted High Efficiency

This type of high efficiency fire has a glass panel across the front of the fire which radiates the heat generated from the fuel effect directly into the room. The glass panel concentrates the radiant heat so that more heat is forced into the room and less is lost through the chimney. Combined with convected heat which is produced by cool air drawn into the base of the fire through the heat exchanger and then emitted as warm air through the gap above the canopy, this makes glass fronted HE's the most efficient conventional flue fires available.

### Hearth Mounted

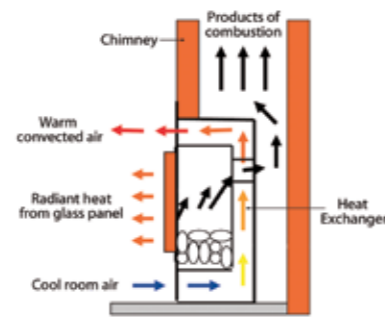

89% net efficiency



Caress HE in brass page 34

### Hole in the Wall

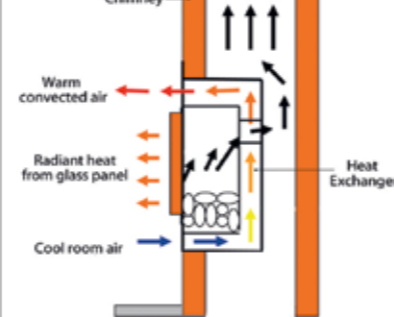

71% net efficiency



Kamina in black page 13

## Outset High Efficiency

### Living Flame Effect

This type of fire sits on the hearth rather than being inset into the chimney. They are glass fronted and work much in the same way as any inset glass fronted fire but with glass panels on both the front and sides of the appliance there is a much larger area of radiant heat generated from the fuel effect.

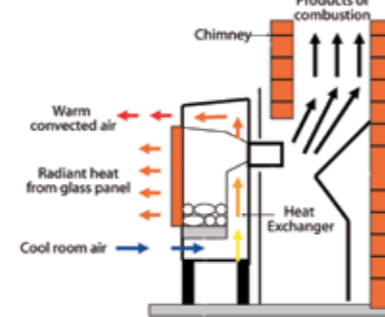

78% net efficiency



Emberglow in black page 41

### Radiant

Outset radiant fires produce both radiant and convected heat. They feature ceramic radiant plaques instead of a coal or pebble effect fuel effect. As they suggest, the ceramic radiant plaques generate radiant heat which is emitted directly into the room. Convected heat is produced by cool air drawn into the base of the fire, through the heat exchanger and then emitted as warm air through the gap at the top of the heater.

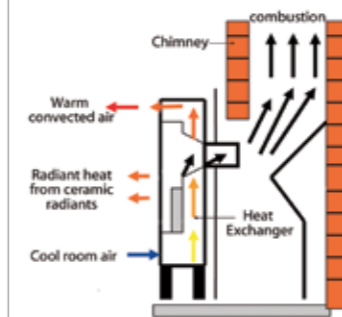

84% net efficiency



Strata in brown page 46

## Balanced Flue High Efficiency

Balanced flue fires are designed for those who want all the benefits of a gas fire but don't have a built in chimney or flue in their home. A balanced flue fire comes with its own flue terminal which is vented directly through an outside wall. They are glass fronted, completely room sealed appliances and work by drawing and venting external air via a pair of co-axial tubes into the fire for combustion purposes. The radiant heat generated from the fuel-bed combines with convected heat, which is produced by cool air drawn into the base of the fire through the heat exchanger and then emitted as warm air through the gap above the canopy, making balanced flues one of the most efficient types of gas fires available.

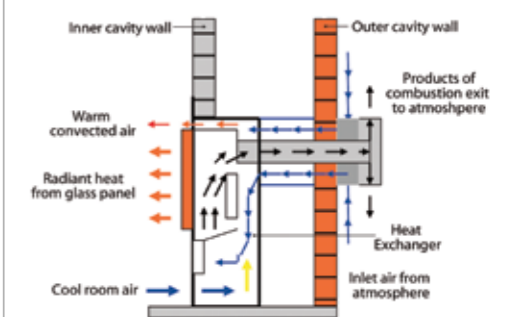

94% net efficiency



Calibre Balanced Flue in silver page 40

Windsor Contemporary Plus.....	18
Windsor Traditional Plus.....	19
Stirling Plus.....	22
Calypso Plus.....	30
Rhapsody Plus.....	31
Kenilworth Plus.....	32
Linear Plus.....	33
Caress Plus.....	34
Richmond Plus.....	35
Decadence Plus.....	36
Opulence Plus.....	37
Expression Plus.....	38

Windsor Contemporary HE.....	20
Windsor Traditional HE.....	21
Kenilworth HE.....	32
Linear HE.....	33
Caress HE.....	34
Decadence HE.....	36
Sophia.....	39

Castelle.....	9
Windsor Wall Mounted.....	11
Curve.....	12
Kamina.....	13
Expression HE.....	14
Diamond HE.....	15
Rocco.....	16
Jazz.....	17

Emberglow.....	41
Renoir.....	42

Regent.....	44
Welcome.....	45
Strata.....	46
Misermatic.....	47
Renaissance.....	48
Firenza.....	49

Rocco Balanced Flue.....	16
Jazz Balanced Flue.....	17
Raglan Balanced Flue.....	25
Orchestra Balanced Flue.....	26
Atlanta Balanced Flue.....	27
Calibre Balanced Flue.....	40
Emberglow Balanced Flue.....	41



# Guide to icons

## Type of Chimney or Flue

The type of chimney or flue you have dictates the type of fire you can have. But if you're not sure, then take a look at your roof and compare it with the simple guide below. It's worth remembering that a full depth fire often requires a traditional chimney or rebate on the fire surround, whilst a slimline fire will fit virtually any chimney or flue.



### Brick Chimney - Class 1 Flues

Apart from products designed for "no chimney" applications, all Flavel products will fit brick chimneys. They are easily recognisable by a chimney stack with accompanying terracotta pot or gas terminal.

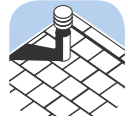

### Pre-Fabricated Flue - Class 2 Flues

Pre-fabricated flues are easily identifiable by a metal flue and terminal on the roof and a metal flue box behind the fire.



### Pre-Cast Flue

Pre-cast flues can be identified by a ridge vent or metal flue tube and terminal on the roof. Constructed from concrete or clay blocks they form a rectangular section flue. All Flavel fires featuring this icon are only suitable for Pre-Cast flues conforming to BS EN 1858.

## Controls



### Manual Control

A simple and discreet control system located behind the fire's trim or fret on inset fires and the bottom right side on outsets.



### Semi Remote Control

Light the fire using the manual control system then use the remote control handset to adjust the flame height and heat output.



### Slide Control

Convenient control that eliminates the necessity of bending down.



### Electronic Flame Control

Discreet easy access buttons are used to ignite the fire and adjust heat and flame height.



### Switch Control

Instant heat at the flick of a switch.



### Remote Control with Thermostat

The remote control handset can be used to light the fire as well as to adjust the flame height and heat output. In addition, the handset contains the extra benefit of a thermostatic control to regulate room temperature and a programmable timer that can be pre-programmed to ensure your room will be warm whenever you wish.



### Top Control

A push down and twist ignition and control located on the top of outset fires means you don't have to bend down to light the fire.



### Remote Control

The remote control handset is used to light the fire as well as adjust the flame height and heat output.



### Electronic Top or Side Control System

Both ignition and heat are controlled by a single rotary motion to light the fire. These easy to use controls are now available on our best selling radiant outsets. Requires an AA battery.

## Can't see a Chimney or Flue?

If you can't see a chimney or flue like the ones described on the left, then you will require either a Balanced Flue or a Powerflue.



### Powerflue

Powerflue fires use an electronically driven fan unit mounted on the external wall to expel the flue gases directly outside the building.



### Balanced Flue

Balanced Flue fires use a horizontal pipe to vent directly outside. An electricity supply is not required for Balanced Flue products.

## Power Supply

Your gas supply will either be natural gas or LPG, depending on the area in which you live.



### Natural Gas

If you have a gas meter then you will have natural gas.



### LPG

LPG is the most popular alternative to natural gas.



### Electric

Simply plug in to your existing household electricity supply.

## Online video



Watch the video

Wherever you see this symbol, use the QR code scanner app on your smartphone or mobile device to watch a short video of this fire.

# Our Flavel gas fire guarantee



Strata brown Page 46



Every model\* carries the peace of mind of a 7 year guarantee and the reassurance of the Flavel Airwatch System on all living flame effect fires. This device immediately cuts off the gas supply in the unlikely event of the flame being extinguished through blockage.

\* Electric fires come with a 2 year guarantee

Our 7 year guarantee is subject to terms & conditions including annual services carried out by a Gas Safe Register engineer and annual replacement of the oxy-pilot assembly (or thermocouple on balanced flue models).

# Calculating your Flavel gas fires running costs

Despite rising fuel prices, natural gas remains the most common and one of the cheapest ways to heat your home. Since the cost of gas can differ depending on service provider, location and tariff we do not include estimated running costs for our products. However, you can estimate your own running costs easily using the following calculation:-

$$\begin{matrix} \text{kW} \\ \text{MAXIMUM} \\ \text{HEAT INPUT} \end{matrix} \times \begin{matrix} \text{£} \\ \text{YOUR GAS} \\ \text{TARIFF} \end{matrix} \times \begin{matrix} \text{0.00} \\ \text{RUNNING} \\ \text{TIME} \end{matrix} = \begin{matrix} \text{£} \\ \text{RUNNING} \\ \text{COST} \end{matrix}$$

Shown for your model in this brochure      Can be found on your latest gas bill      The length of time your fire is turned on.

### Example

What is the running cost of the Windsor Traditional HE when used for 3 hours at a cost of 4.2p per kilowatt hour?

$$\begin{matrix} \text{4.0kW} \\ \text{MAXIMUM} \\ \text{HEAT INPUT} \end{matrix} \times \begin{matrix} \text{4.2p} \\ \text{GAS TARIFF} \end{matrix} \times \begin{matrix} \text{3 hours} \\ \text{RUNNING} \\ \text{TIME} \end{matrix} = \begin{matrix} \text{50.4p} \\ \text{RUNNING} \\ \text{COST} \end{matrix}$$



Windsor Traditional HE brass Page 19





## Flavel Fires Efficiency Guide

Whether your home has a brick chimney, pre-fabricated flue or pre-cast (BS EN 1858) flue you will be able to choose any fire from pages 8 to 38. We offer a huge range of products from radiant outlets to hole-in-the-wall fires. Your choice will depend on both the look and performance which is most suitable for you.

We offer a wide variety of products and each one offers different levels of energy efficiency. Depending on the style you would like, the hours of use, and the initial price you would like to pay, the most efficient gas fire may not always be the correct choice for you.

We have created the efficiency guide below to help you discover which type of fire is most suitable for you. We have clearly labelled each fire in this brochure to allow you to quickly and easily identify the level of efficiency that you can expect from that model.

### Ultra High Efficiency Gas Fires - Net Efficiency 76%+

Ultra High Efficiency gas fires are exceptionally efficient and offer the largest energy cost saving per kilowatt of gas used to run the fire. These products tend to be glass fronted, radiant outset fires or balanced flue models. For more information about each of these product types see pages 4 and 5.

### High Efficiency Gas Fires - Net Efficiency 66% to 75%

High Efficiency gas fires are very efficient and offer both style and performance. Many of these products are open fronted convector, referred to as 'Plus' models in this brochure. They give you the look and feel of a real fire with maximum heat output. This category also includes some outset radiant heaters. For more information please see pages 4 and 5.

### Standard Efficiency Gas Fires - Net efficiency 50% to 65%

Standard Efficiency gas fires can be used as a secondary heat source in conjunction with central heating. These products are ideal if you are looking for a great fireplace feature for occasional use.

### Decorative Gas Fires - Net Efficiency up to 49%

These fires should be purchased for decorative purposes only and not used as a primary or secondary heat source. They provide a stunning focal point and help to create the ambiance of a real fire.



Castelle Slimline High Efficiency



Hole in the Wall



Brick Chimney



Pre-Fabricated Flue



Pre-Cast Flue

## Castelle Slimline

The Castelle Slimline has been specifically designed to fit a standard Pre-Cast flue without compromising style and performance. It features a striking curved black glass fascia, framing a beautifully realistic log fuel effect and a fully automatic remote control system.

Safety Features: Flame Supervision Device & Airwatch System

Specification			Control Options	Fire Back	Fuel Effect
Heat Input (max)	Heat Output (max)	Net Efficiency	Remote	Reflective	Log
5.0kW	3.1kW	71%	✓	✓	✓

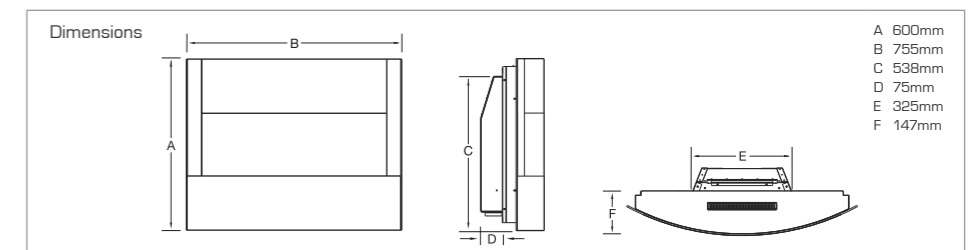

Caress Plus Contemporary in brass High Efficiency See page 34



Finesse in brass



Standard Efficiency



Watch the video

Windsor Plus Wall Mounted



High Efficiency



Hole in the Wall

Hole in the Wall

# Finesse



Brick Chimney



Pre-Fabricated Flue



Pre-Cast Flue

The most versatile hole-in-the-wall gas fire from Flavel. The Finesse will fit virtually any flue and is available in three different variations – a brass trim option with coal fuel effect to suit a classical setting and a chrome trim option with a choice of coal or pebble fuel effect.

Safety Features: Flame Supervision Device & Airwatch System

Specification		Control Options	Fire Back	Fuel Effect		Colour Options	
Heat Input (max)	Heat Output (max)	Manual	Plain	Coal	Pebble	Brass*	Chrome
6.5kW	3.3kW	56%	✓	✓	✓	✓	✓

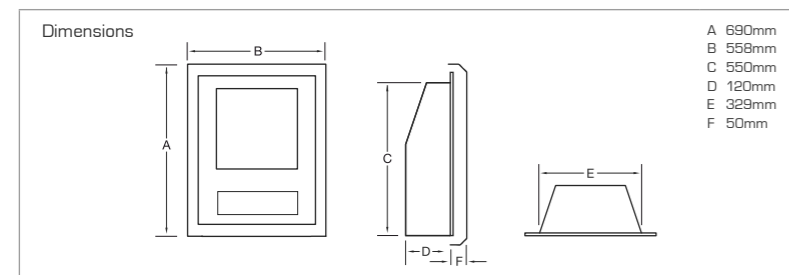

Finesse with coal fuel effect and chrome trim



Finesse with pebble fuel effect and chrome trim



Windsor HE with coal fuel effect



Windsor Contemporary with pebble fuel effect



Brick Chimney



Pre-Fabricated Flue



Pre-Cast Flue

# Windsor Contemporary Wall Mounted

The Windsor Wall Mounted is available in a choice of models including open-fronted, open-fronted 'Plus' and glass fronted 'HE'. Each model comes with the option of a coal or pebble fuel bed and features a large viewing window. This extremely versatile fire will fit into almost any chimney or flue.

Safety Features: Flame Supervision Device & Airwatch System

Specification	Heat Input (max)	Heat Output (max)	Net Efficiency	Control Options	Fire Back	Fuel Effect	
				Manual	Plain	Coal	Pebble
Windsor Contemporary HE	4.0kW	3.2kW	89%	✓	✓	✓	✓
Windsor Contemporary Plus	6.5kW	4.1kW	70%	✓	✓	✓	✓
Windsor Contemporary	6.5kW	3.3kW	56%	✓	✓	✓	✓

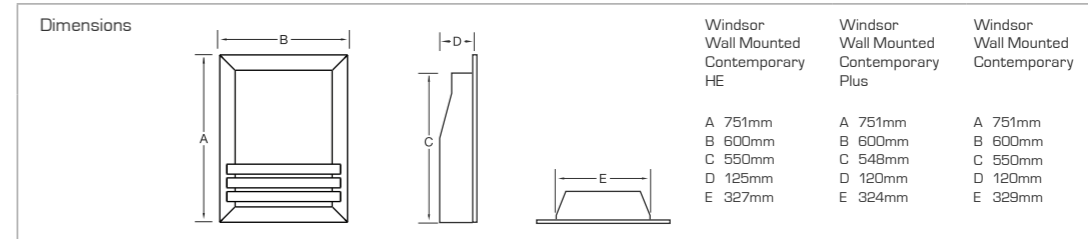

Curve in black



High Efficiency



Wall Mounted



Kamina in black



High Efficiency



Wall Mounted

## Curve



Brick Chimney



Pre-Fabricated Flue



Pre-Cast Flue



Brick Chimney



Pre-Fabricated Flue



Pre-Cast Flue

## Kamina

The Curve “hang-on-the-wall” fire with its sleek lines, textured fascia and glass front, complements the unique flame pattern created by an undulating back panel. This stunning fire is easy to install as it literally hangs on the wall, rather than slotting into the structure. The Curve is perfectly suited to contemporary homes requiring state-of-the-art appearance and the performance to match.

The sleek black glass fascia on this “hang-on-the-wall” gas fire is perfectly complemented by the unique flame pattern created by an undulating back panel. Installation is virtually hassle free as this highly contemporary fire literally hangs on the wall, thereby minimising any costly or messy building work. With a maximum heat output of 4kW the Kamina is perfectly suited to contemporary homes requiring state-of-the-art appearance and performance.

Safety Features: Flame Supervision Device & Airwatch System

Specification

Heat Input (max)	Heat Output (max)	Net Efficiency	Control Options		Fuel Effect		Colour Options	
			Remote	Flame Only	Black	Graphite Grey		
6.5kW	4.0kW	71%	✓	✓	✓	✓		

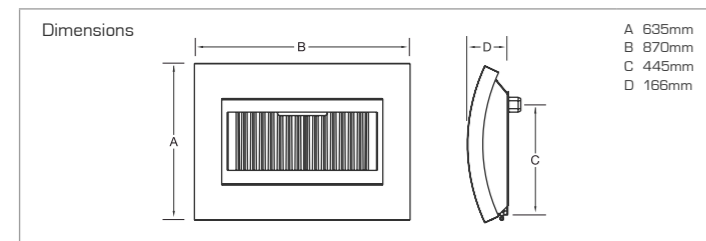

Curve in graphite grey

Safety Features: Flame Supervision Device & Airwatch System

Specification

Heat Input (max)	Heat Output (max)	Net Efficiency	Control Options		Fuel Effect	
			Remote	Flame Only	Black	Graphite Grey
6.5kW	4.0kW	71%	✓	✓		

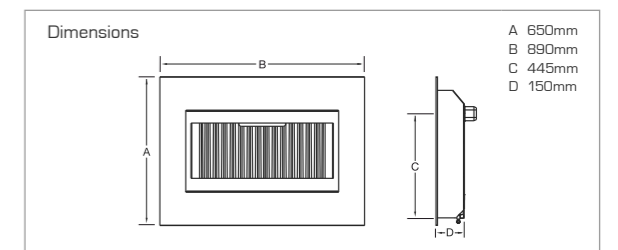





Hole in the Wall

Hole in the Wall

## Expression HE



Brick Chimney



Pre-Fabricated Flue



Pre-Cast Flue



Brick Chimney



Pre-Fabricated Flue

## Diamond HE

The Flavel Expression HE hole in the wall high efficiency gas fire is a contemporary and economical heating solution with a net efficiency of 78%. This fully glass fronted model features a stunning stainless steel fascia design and is operated by a fully automatic remote control system.

As Flavel's debut high efficiency hole-in-the-wall fire, the Diamond HE is a contemporary and economical heating solution with a net efficiency of 78%. This fully glass fronted model features the stunning 'Diamond' fascia design and is available with a choice of coal or pebble fuel effect.

Safety Features: Flame Supervision Device & Airwatch System

Specification			Control Options	Fuel Effect
Heat Input (max)	Heat Output (max)	Net Efficiency	Remote with Thermostat	Coal
4.5kW	3.2kW	78%	✓	✓

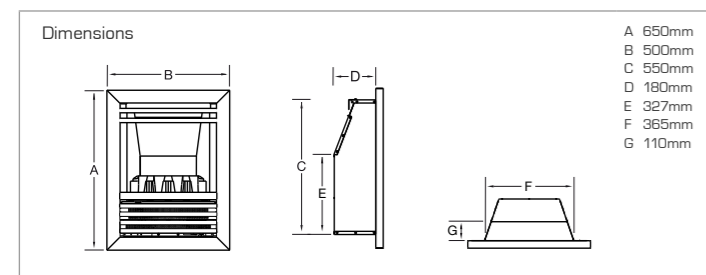

Safety Features: Flame Supervision Device & Airwatch System

Specification			Control Options	Fire Back	Fuel Effect	
Heat Input (max)	Heat Output (max)	Net Efficiency	Remote with Thermostat	Plain	Coal	Pebble
4.5kW	3.2kW	78%	✓	✓	✓	✓

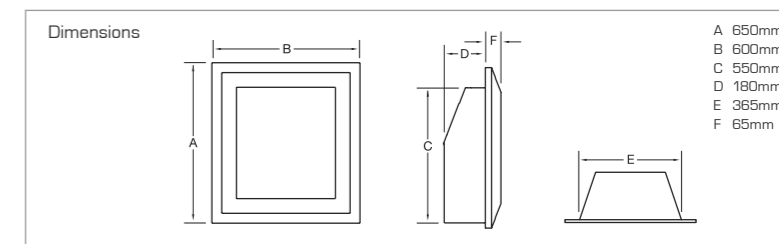

Diamond HE with pebble fuel effect



Rocco HE black back with silver trim

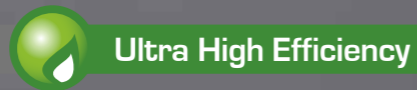

Hole in the Wall



Jazz HE in black with black trim



Hole in the Wall



Watch the video

# Rocco HE



This stunning glass fronted hole-in-the-wall fire features a realistic log fuel effect and comes in a range of fascia and back panel colour combinations.

Safety Features: Flame Supervision Device & Airwatch System (not applicable to balanced flue models)

Specification	Heat Input (max)	Heat Output (max)	Net Efficiency	Control Options		Fire Back	Fuel Effect	Colour Options			
				Semi Remote	Remote			Black back		Cream back	
						Ribbed	Log	Black	Silver	Champagne	Champagne
Rocco HE	5.4kW	4.2kW	87%	✓	✓	✓	✓	✓	✓	✓	✓
Rocco BF	7.5kW	5.5kW	87%	✓	✓	✓	✓	✓	✓	✓	✓

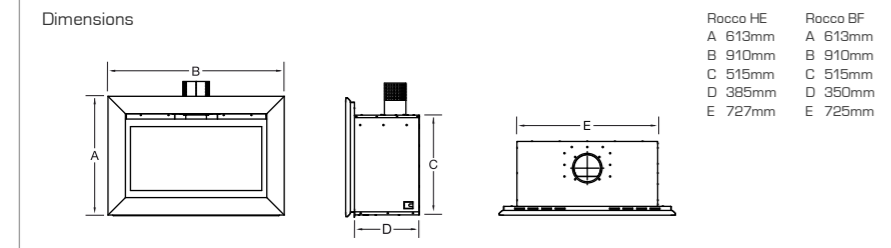

Rocco HE black back with black trim



Rocco HE cream back with champagne trim



Rocco HE black back with champagne trim



Jazz black back with silver trim



Jazz cream back with champagne trim



# Jazz HE

This stunning glass fronted hole-in-the-wall fire has petite dimensions and a highly realistic log fuel effect. The Jazz HE black back model comes complete with high quality trims in three finishes – silver, champagne and black. The Jazz cream back is complemented by a champagne trim. Jazz Balanced Flue features a black back with a choice of silver or black trim.

Safety Features: Flame Supervision Device & Airwatch System (not applicable to balanced flue models)

Specification	Heat Input (max)	Heat Output (max)	Net Efficiency	Control Options		Fire Back	Fuel Effect	Colour Options			
				Semi Remote	Remote			Black back		Cream back	
						Ribbed	Log	Black	Silver	Champagne	Champagne
Jazz HE	5.4kW	4.2kW	87%	✓	✓	✓	✓	✓	✓	✓	✓
Jazz BF	5.5kW	4.2kW	84%	✓	✓	✓	✓	✓	✓	✓	✓

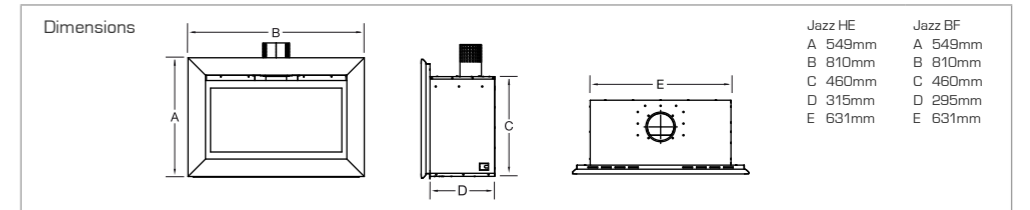



Windsor Contemporary Plus with pebble fuel effect  High Efficiency



Watch the video

Slimline

Windsor Traditional in brass  Standard Efficiency



Watch the video

Slimline

## Windsor Contemporary



Stunning styling makes the Windsor Contemporary the centrepiece of your room. This slimline gas fire will fit almost any chimney or flue, including Pre-Cast (BS EN 1858) and is available as a glass fronted HE (high efficiency), open-fronted Plus or the standard open fronted model.

Safety Features: Flame Supervision Device & Airwatch System

Model	Heat Input (max)	Heat Output (max)	Net Efficiency	Control Options		Fire Back			Fuel Effect			Colour Options		
				Manual	Slide	Plain	Brick	Coal	Pebble	Driftwood	Brass	Polished Silver	Brushed Silver	
Windsor Contemporary HE	4.0kW	3.2kW	89%	✓	✓	✓	✓	✓	✓	✓	✓	✓	✓	✓
Windsor Contemporary Plus	6.5kW	4.1kW	70%	✓	✓	✓	✓	✓	✓	✓	✓	✓	✓	✓
Windsor Contemporary	6.5kW	3.3kW	56%	✓	✓	✓	✓	✓	✓	✓	✓	✓*	✓	✓

\*Not available with pebble fuel effect.

Dimensions

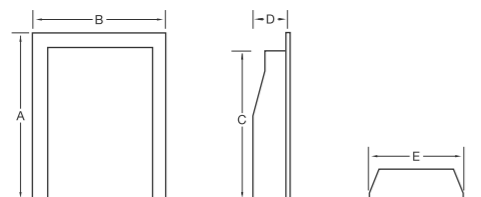

Windsor Contemporary HE	Windsor Contemporary Plus	Windsor Contemporary
A 592mm	A 592mm	A 592mm
B 475mm	B 475mm	B 475mm
C 550mm	C 548mm	C 550mm
D 125mm	D 120mm	D 120mm
E 327mm	E 324mm	E 329mm

Windsor Contemporary with brass trim and coal fuel effect

Windsor Contemporary with silver trim and driftwood fuel effect



## Windsor Traditional & Classic

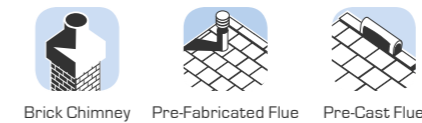

The Windsor Traditional is available as a standard radiant model, glass fronted HE model and also the open fronted plus platform. Each model offers exceptional heat output and is available in manual control. The Windsor Traditional HE is available in Slide control. The more modern Windsor classic is available in brass or silver with an attractive Grace Fret.

Safety Features: Flame Supervision Device & Airwatch System

Model	Heat Input (max)	Heat Output (max)	Net Efficiency	Control Options		Fire Back Design			Fuel Effect		Colour Options	
				Manual	Slide	Plain	Brick	Coal	Brass	Silver		
Windsor Traditional HE	4.0kW	3.2kW	89%	✓	✓	✓	✓	✓	✓	✓	✓	
Windsor Traditional Plus	6.5kW	4.1kW	70%	✓	✓	✓	✓	✓	✓	✓	✓	
Windsor Traditional	6.5kW	3.3kW	56%	✓	✓	✓	✓	✓	✓	✓	✓	
Windsor Classic	6.5kW	3.3kW	56%	✓	✓	✓	✓	✓	✓	✓	✓	

Dimensions

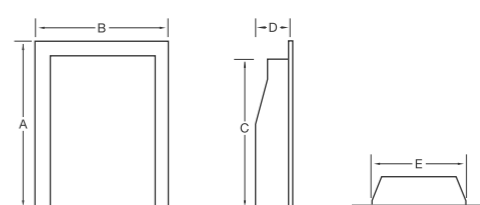

Windsor Traditional HE	Windsor Traditional Plus	Windsor Traditional & Classic
A 592mm	A 592mm	A 592mm
B 475mm	B 475mm	B 475mm
C 550mm	C 548mm	C 550mm
D 125mm	D 120mm	D 120mm
E 327mm	E 324mm	E 329mm

Windsor Traditional HE in silver

Windsor Traditional Plus in brass

Windsor Classic in silver





Melody in silver  Standard Efficiency



Slimline



Warwick in brass  Standard Efficiency



Slimline



## Melody



The Melody is an elegant slimline fire enabling installation in almost any flue including pre-cast. The discreet slide control ensures convenient operation with a heat output of up to 3.3kW.

Safety Features: Flame Supervision Device & Airwatch System

Specification		Control Options	Fire Back	Fuel Effect	Colour Options				
Heat Input [max]	Heat Output [max]	Net Efficiency	Slide	Plain	Coal	Brass	Brass and Black	Black	Silver
6.5kW	3.3kW	56%	✓	✓	✓	✓	✓	✓	✓

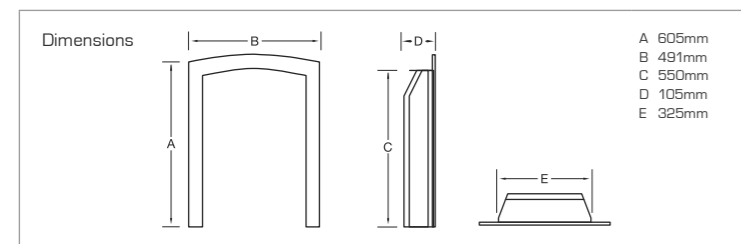

Melody in brass and black



Melody in black



Melody in brass



Warwick with black trim and Balmoral black fret



Warwick with silver trim and Grace silver fret

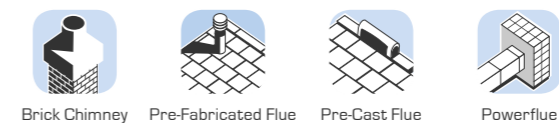

## Warwick & Warwick Powerflue

This ultra slim Warwick gas fire will fit almost any chimney or flue, and has an impressive 3.3kW heat output.

Safety Features: Flame Supervision Device & Airwatch System

Specification		Control Options	Fire Back	Fuel Effect	Colour Options				
Model	Heat Input [max]	Heat Output [max]	Net Efficiency	Manual	Plain	Coal	Brass	Black	Silver
Warwick	6.5kW	3.3kW	56%	✓	✓	✓	✓	✓	✓
Warwick Powerflue	6.5kW	3.2kW		✓	✓	✓	✓	✓	✓

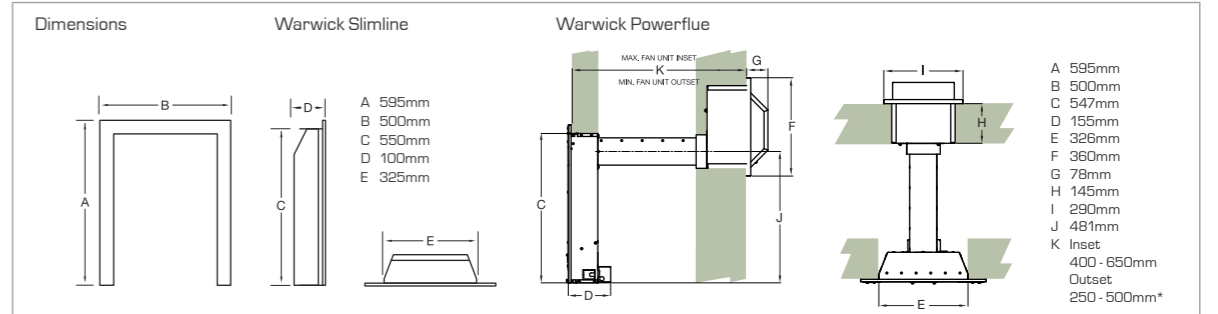

\*Maximum flue length 5 metres and 3 bends.





Slimline



Slimline

## Stirling Plus



The Stirling Plus open fronted high efficiency slimline gas fire will fit into all flue types and, with a very impressive heat output of 4.1kW, is sure to be a popular choice. The Stirling Plus is operated by a choice of manual or EFC control and is available in either a black or brass finish.

Safety Features: Flame Supervision Device & Airwatch System

Specification		Control Options		Fire Back	Fuel Effect	Colour Options	
Heat Input [max]	Heat Output [max]	Manual	EFC	Plain	Coal	Brass	Black
6.5kW	4.1kW	70%	✓	✓	✓	✓	✓

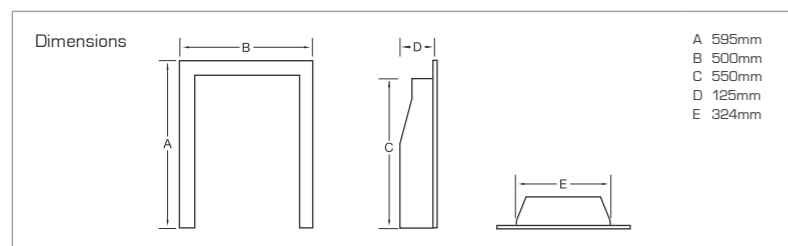

Stirling Plus with brass trim and Blenheim antique fret



Caress Slimline Slide Control in polished cast iron

## Caress Slimline

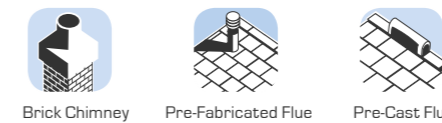

The Caress Slimline gas fire features a fabulous, top quality cast trim and Blenheim fret in a choice of solid cast brass or polished silver cast iron.

Safety Features: Flame Supervision Device & Airwatch System

Specification	Model	Heat Input [max]	Heat Output [max]	Net Efficiency	Control Options		Fire Back	Fuel Effect	Colour Options	
					Manual	Slide	Plain	Coal	Brass	Silver
Caress Plus	6.5kW	4.4kW	70%	✓	✓	✓	✓	✓	✓	✓
Caress Slimline	6.5kW	3.3kW	56%	✓	✓	✓	✓	✓	✓	✓

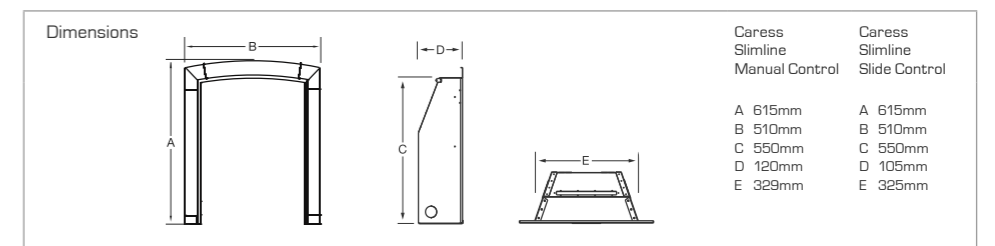



SHOWROOM EXCLUSIVE

Decadence HE Slimline

High Efficiency



Raglan Balanced Flue in brass

Ultra High Efficiency



Slimline

Slimline

## Decadence HE Slimline



The Decadence Slimline HE high efficiency gas fire boasts an amazing 89% net efficiency and will fit almost any chimney or flue, including Pre-cast (BS EN 1858). This fully glass fronted model is available with a realistic coal fuel effect and is available in a choice of gold, silver or black nickel finishes.

Safety Features: Flame Supervision Device & Airwatch System

Specification			Control Options	Fire Back	Fuel Effect	Colour Options		
Heat Input (max)	Heat Output (max)	Net Efficiency	Manual	Plain	Coal	Gold	Silver	Black Nickel
4.0kW	3.2kW	89%	✓	✓	✓	✓	✓	✓

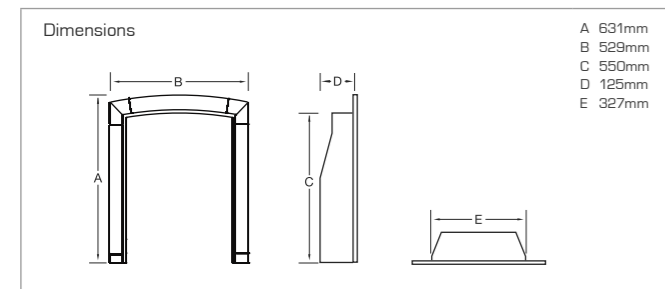

Decadence HE in gold



Decadence HE in black nickel



Raglan Balanced Flue in silver

## Raglan Balanced Flue



With a net efficiency of 80% the stylish Raglan Balanced Flue is designed to fit into houses without a chimney or flue and its glass front does more than simply look great, it increases efficiency too.

Safety Features: Flame Supervision Device

Specification			Control Options	Fire Back	Fuel Effect	Colour Options	
Heat Input (max)	Heat Output (max)	Net Efficiency	Manual	Plain	Coal	Brass	Silver
3.8kW	2.8kW	80%	✓	✓	✓	✓	✓

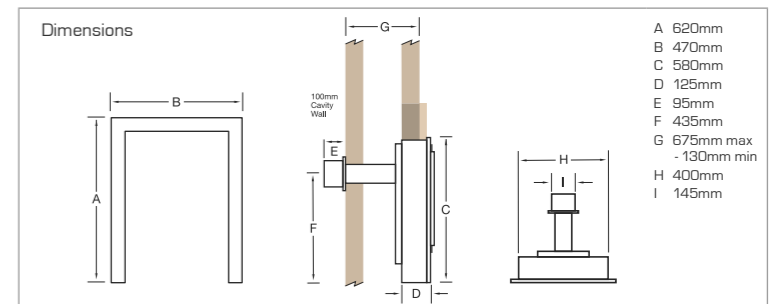



Orchestra Balanced Flue in silver

Ultra High Efficiency



Image shown represents the Orchestra natural gas model. Flame picture may differ on LPG model.

Slimline

Atlanta Balanced Flue in silver

High Efficiency



Slimline

## Orchestra Balanced Flue



Balanced Flue

If you want the warmth and mood created by a living flame fire yet don't have a chimney or flue, then the Orchestra is the perfect solution. This neat, glass fronted inset fire with a net efficiency of 80% is framed by a chamfered trim and sleek fret.

Safety Features: Flame Supervision Device

Specification

Heat Input (max)	Heat Output (max)	Net Efficiency	Fuel Options		Control Options	Fire Back	Fuel Effect	Colour Options	
			Natural Gas	LPG	Manual	Plain	Coal	Brass	Silver
3.8kW	2.8kW	80%	✓	✓	✓	✓	✓	✓	✓

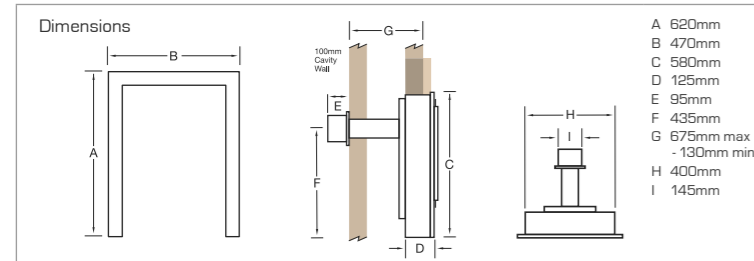

Orchestra Balanced Flue in brass

## Atlanta Balanced Flue



Balanced Flue

Simplicity of form. Complexity of flame. The Atlanta's clean lines compliment its clean burning efficiency. The glass front amplifies a unique flame pattern through an undulating back panel. Offset against a brushed steel trim it conjures up an ethereal yet comforting minimalism.

Safety Features: Flame Supervision Device

Specification

Heat Input (max)	Heat Output (max)	Net Efficiency	Control Options	Fuel Effect
			Manual	Flame Only
4.0kW	2.8kW	66%	✓	✓

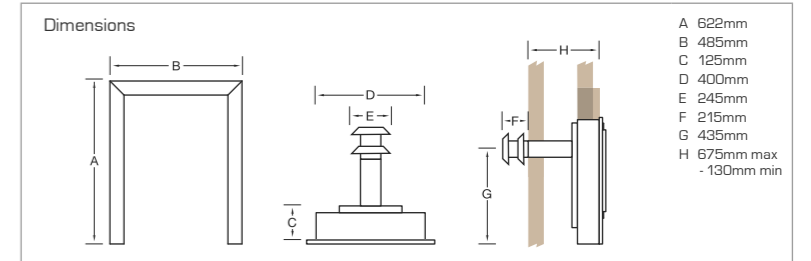



# Online inspiration & information

Tap into a wealth of knowledge and discover everything you need to know about purchasing, fitting and servicing your Flavel fire.

- Use our intelligent search tools to find your perfect gas fire
- Find your nearest Flavel Approved Stockist
- Download Installation and User manuals
- Register your guarantee
- Watch videos of our stunning fires
- Instant Live Chat facility on the website
- Interactive updated Blogs to keep you informed and intrigued

[www.flavelfires.co.uk](http://www.flavelfires.co.uk)



At the heart of your home



Brick Chimney



Pre-Fabricated Flue

## Waverley

The Waverley, with its beautiful decorative flame effect, is a perfect replacement for a solid fuel grate. The 16" tapered inset tray is designed to fit a standard 16" fire back, providing a realistic coal effect for almost any style of fireplace.

Safety Features: Flame Supervision Device & Airwatch System

Specification	Control Options	Fuel Effect
Heat Input (max)	Manual	Coal
6.9kW	✓	✓
Heat Output (max)		
2.0kW		

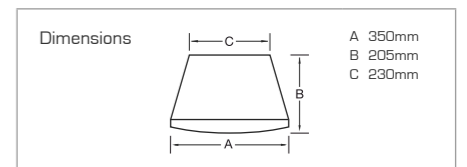



Calypso Plus High Efficiency



Full Depth

Rhapsody Plus in silver High Efficiency



Full Depth

# Calypso

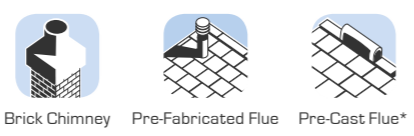

The Calypso successfully combines exceptional fire design with today's necessity for convenience in the form of a user friendly dual directional slide control. This fire will be equally at home in a contemporary or traditional fire surround and room setting.

Safety Features: Flame Supervision Device & Airwatch System

Specification	Heat Input (max)	Heat Output (max)	Net Efficiency	Control Options		Fuel Effect
				Slide	Plain	
Calypso	6.9kW	4.4kW	65%	✓	✓	✓
Calypso Plus	6.9kW	3.9kW	70%	✓	✓	✓

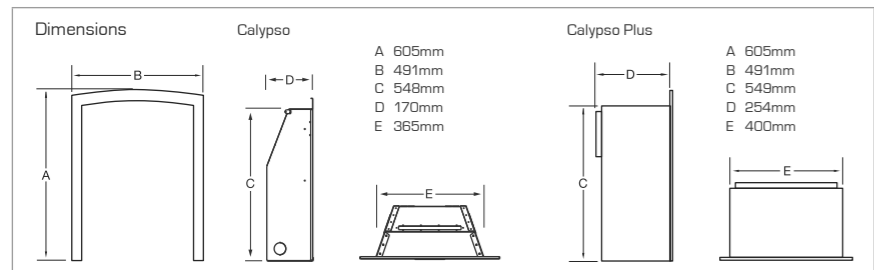

\*Calypso Plus only.



Calypso

# Rhapsody

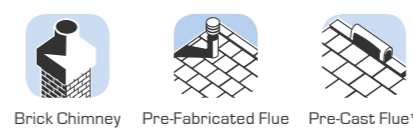

The classic Rhapsody open fronted fire has a very realistic full depth fuel effect and beautiful flame picture making it indistinguishable from a real coal fire. With its elegant arched trim and striking fret the Rhapsody is a timeless classic.

Safety Features: Flame Supervision Device & Airwatch System

Specification	Heat Input (max)	Heat Output (max)	Net Efficiency	Fuel Options		Control Options		Fire Back	Fuel Effect	Colour Options			
				Natural Gas	LPG	Slide	Plain			Brass	Brass and Black	Black	Silver
Rhapsody Plus	6.9kW	4.4kW	70%	✓		✓	✓	✓	✓	✓	✓	✓	✓
Rhapsody	6.9kW	4.0kW	65%	✓	✓	✓	✓	✓	✓	✓	✓	✓	✓

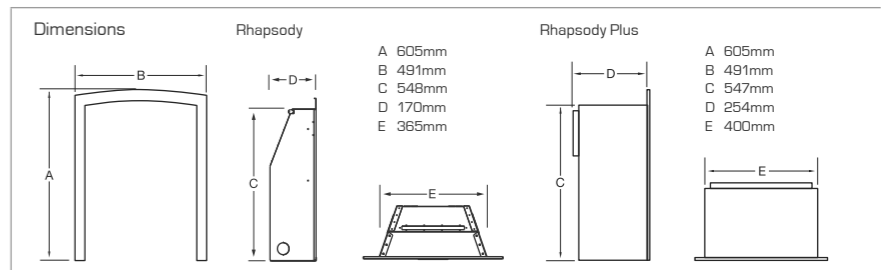

\*Rhapsody Plus only.



Rhapsody in black



Rhapsody in silver



Rhapsody Plus in brass and black



Kenilworth Plus in brass with Balmoral fret

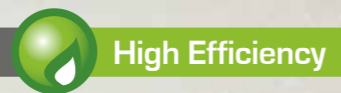

Watch the video

Full Depth

Linear Plus with coal fuel effect



Watch the video

Full Depth

# Kenilworth

Kenilworth Plus, HE & Powerflue

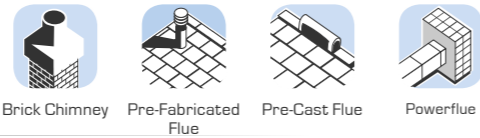

The Kenilworth gas fire features a welcoming full depth coal fuel effect and will fit most chimney and flue types including a precast flue with a 3" rebate on the fire surround.

Safety Features: Flame Supervision Device & Airwatch System

Specification

Model	Heat Input (max)	Heat Output (max)	Net Efficiency	Control Options			Fire Back	Fuel Effect	Colour Options								
				Manual	Slide	Remote with Thermostat			Plain	Coal	Balmoral	Grace	Brass	Black	Brass	Silver	
Kenilworth HE	4.5kW	3.2kW	78%	✓		✓	✓	✓	✓	✓	✓	✓	✓	✓	✓	✓	✓
Kenilworth Plus	6.9kW	4.4kW	70%	✓	✓	✓	✓	✓	✓	✓	✓	✓	✓	✓	✓	✓	✓
Kenilworth	6.9kW	3.3kW	53%	✓		✓	✓	✓	✓	✓	✓	✓	✓	✓	✓	✓	✓
Kenilworth Powerflue	6.9kW	3.6kW		✓			✓	✓	✓	✓	✓	✓	✓	✓	✓	✓	✓

Kenilworth HE in black



Kenilworth Plus in silver

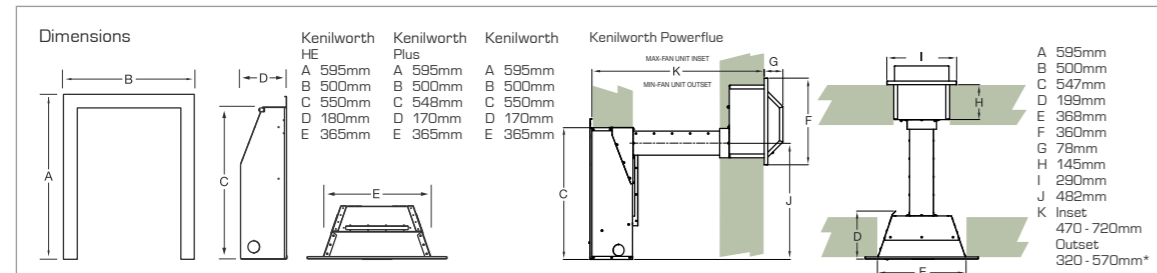

\*Maximum flue length 5 metres and 3 bends.

# Linear

Linear Plus, HE & Powerflue

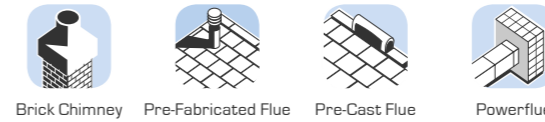

The Linear is a stunning modern design with the combination of black ribbed back panels and polished silver fascia. This full depth gas fire delivers a wonderful flickering glow and can be installed into almost any chimney or flue including a pre-cast flue with a 3" rebated surround.

Safety Features: Flame Supervision Device & Airwatch System

Specification

Model	Heat Input (max)	Heat Output (max)	Net Efficiency	Control Options			Fire Back	Fuel Effect	Colour Options
				Manual	Ribbed	Coal			
Linear HE	4.5kW	3.2kW	78%	✓	✓	✓	✓	✓	✓
Linear Plus	6.9kW	4.4kW	70%	✓	✓	✓	✓	✓	✓
Linear	6.9kW	3.3kW	53%	✓	✓	✓	✓	✓	✓
Linear Powerflue	6.9kW	3.6kW		✓	✓	✓	✓	✓	✓

Linear with pebble fuel effect



Linear HE with coal fuel effect

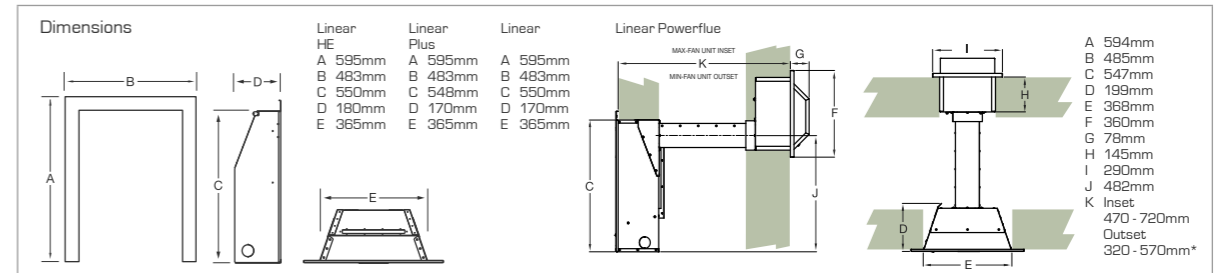

\*Maximum flue length 5 metres and 3 bends.



Caress Plus Contemporary in silver



Standard Efficiency



\*Images shown represents the Caress HE natural gas model. Flame picture may differ on LPG model.

Full Depth



Watch the video

Richmond Plus in brass



High Efficiency



Full Depth



Watch the video

# Caress

## Caress Plus & Caress HE



Brick Chimney



Pre-Fabricated Flue

The Caress full depth living flame effect convector gas fire boasts an impressive 4kW heat output (3.3kW on Plus model) and incredible efficiency. It is available in a choice of Traditional or Contemporary styling and both versions come in a choice of solid cast brass or polished silver cast iron.

Safety Features: Flame Supervision Device & Airwatch System

Specification	Heat Input (max)	Heat Output (max)	Net Efficiency	Fuel Options		Control Options			Fire Back	Fuel Effect	Colour Options						
				Natural Gas	LPG*	Manual	Slide	Remote			Plain	Coal	Traditional Brass	Traditional Silver	Contemporary Brass	Contemporary Silver	
Caress HE	5.0kW	4.0kW	89%	✓	✓	✓	✓	✓	✓	✓	✓	✓	✓	✓	✓	✓	✓
Caress Plus	6.5kW	4.4kW	70%	✓	✓	✓	✓	✓	✓	✓	✓	✓	✓	✓	✓	✓	✓
Caress	6.9kW	4.4kW	65%	✓	✓	✓	✓	✓	✓	✓	✓	✓	✓	✓	✓	✓	✓

Dimensions			Caress HE	Caress Plus	Caress Contemporary & Brass
A	B	D	615mm	615mm	615mm
C	E		510mm	510mm	510mm
			550mm	548mm	550mm
			230mm	170mm	250mm
			400mm	365mm	400mm

\*LPG model only available with manual control operation.

Caress HE Traditional in silver



Caress Plus Traditional in brass



Caress Contemporary in brass



Brick Chimney



Pre-Fabricated Flue

# Richmond

## & Richmond Plus

You can now achieve the look of a real open coal fire, combined with the convenience of gas fuel. The Richmond full depth convector fire combines a brilliant flame effect with high efficiency and outstanding warmth. The Richmond features a Profiled trim and Dallas fret and is available in black, silver or brass finishes.

Safety Features: Flame Supervision Device & Airwatch System

Specification	Heat Input (max)	Heat Output (max)	Net Efficiency	Control Options			Fire Back	Fuel Effect	Colour Options			
				Manual	Slide	Remote			Plain	Coal	Brass	Black
Richmond Plus	6.9kW	4.6kW	74%	✓	✓	✓	✓	✓	✓	✓	✓	✓
Richmond	6.9kW	4.0kW	65%	✓	✓	✓	✓	✓	✓	✓	✓	✓

Dimensions			Richmond Plus	Richmond
A	B	D	600mm	595mm
C	E		498mm	500mm
			548mm	550mm
			223mm	250mm
			400mm	400mm

Richmond in black



Richmond Plus in silver





SHOWROOM EXCLUSIVE

Decadence Plus in black nickel

High Efficiency



Watch the video

Full Depth

Opulence Plus

High Efficiency

SHOWROOM EXCLUSIVE



Watch the video

Full Depth

## Decadence Plus & Decadence HE



Brick Chimney



Pre-Fabricated Flue



Pre-Cast Flue

This striking open fronted full depth gas fire features a choice of three beautiful high quality cast iron fascia's available in a choice of Gold, Silver or Black Nickel plated finishes.

Safety Features: Flame Supervision Device

Specification

	Heat Input (max)	Heat Output (max)	Net Efficiency	Fuel Options	Control Options			Fire Back	Fuel Effect	Colour Options		
				Natural Gas	Manual	Slide	Remote with Thermostat	Plain	Coal	Gold	Silver	Black Nickel
Decadence Plus	6.9kW	4.4kW	70%	✓	✓	✓	✓	✓	✓	✓	✓	✓
Decadence HE	6.5kW	3.2kW	78%	✓	✓	✓	✓	✓	✓	✓	✓	✓



Decadence HE in gold



Decadence HE in silver

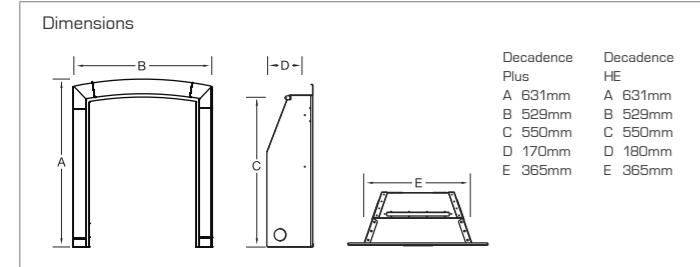

Brick Chimney



Pre-Fabricated Flue



Pre-Cast Flue

## Opulence Plus

The Flavel Opulence Plus high efficiency gas fire boast an impressive 70% net efficiency and can be installed in to almost any chimney or flue, include Pre-cast when fitted with a 3" rebated fire surround. This open-fronted gas fire features a highly realistic coal fuel effect and is available as a manual, easy flame or fully automatic remote controlled fire. The Opulence Plus comes in choice of brass or silver finishes.

Safety Features: Flame Supervision Device & Airwatch System

Specification

	Heat Input (max)	Heat Output (max)	Net Efficiency	Power	Control Options			Fuel Effect	Colour Options	
				Natural Gas	Manual	EFC	Remote	Coal	Brass	Silver
Opulence Plus	6.9kW	4.4kW	70%	✓	✓	✓	✓	✓	✓	✓

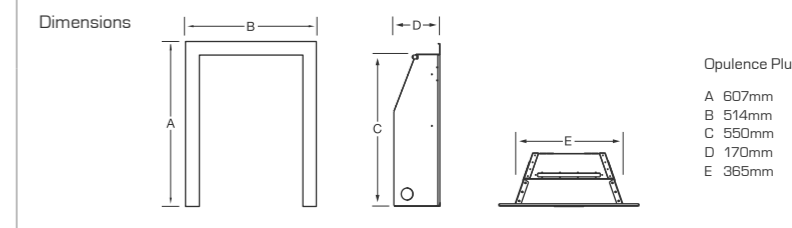

Opulence in silver





Expression Plus

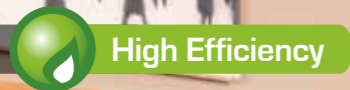

Watch the video

Full Depth



Sophia Suite

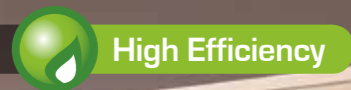

Watch the video

Full Depth

# Expression Plus

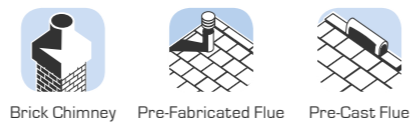

Brick Chimney Pre-Fabricated Flue Pre-Cast Flue

The Flavel Expression Plus high efficiency gas fire boast an impressive 70% net efficiency and can be installed in to almost any chimney or flue, include Pre-cast when fitted with a 3" rebated fire surround. This open-fronted gas fire features a coal fuel effect and comes with a contemporary stainless steel one-piece fascia. The Expression Plus is available with manual, slide, easy flame or fully automatic remote control.

Safety Features: Flame Supervision Device

Specification		Fuel Options	Control Options				Fuel Effect	Colour Options
Heat Input (max)	Heat Output (max)	Natural Gas	Manual	Slide	EFC	Remote	Coal	Silver
6.9kW	4.4kW	70%	✓	✓	✓	✓	✓	✓

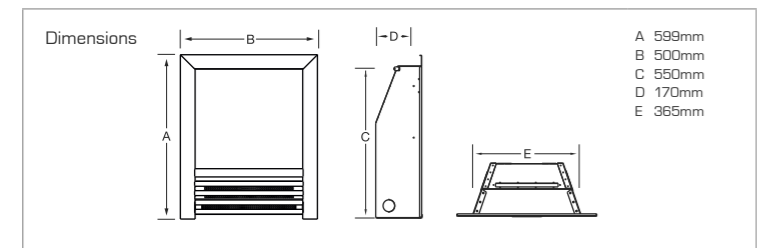

# Sophia Suite



Brick Chimney Pre-Fabricated Flue

The Flavel Sophia gas fire suite features a large, high efficiency, log effect gas fire framed by a beautifully designed Royal Botticino stone surround.

This conventionally flued gas fire is suitable for installation into a standard brick chimney or pre-fabricated flue, and is operated by a multifunctional remote control handset. The remote control system includes a thermostatic operation which automatically adjusts the heat output up or down to maintain your desired pre-set temperature. There is also a wake/sleep timer function which lets you specify when the fire will automatically turn on and turn off.

For optimum efficiency the Sophia comes with a built in electronic fan that is use to circulate convected heat around the room. This ensures that the whole of the room is kept warm, not just the area immediately in front of the fire.

Safety Features: Flame Supervision Device & Airwatch System

Specification		Fuel Options	Control Options	Fuel Effect
Heat Input (max)	Heat Output (max)	Natural Gas	Remote with Thermostat	Log
76kW	4.8kW	70%	✓	✓

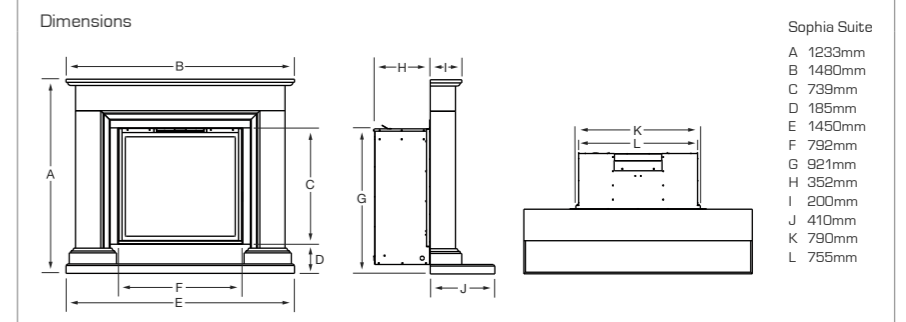



Calibre Balanced Flue in silver



Ultra High Efficiency



Watch the video

Full Depth

Image shown represents the Calibre natural gas model. Flame picture may differ on LPG model.

Emberglow



Ultra High Efficiency



Watch the video

Outlet

Image shown represents the Emberglow natural gas model. Flame picture may differ on LPG model.

## Calibre Balanced Flue



Balanced Flue

The Calibre Balanced Flue gas fire boasts a net efficiency of up to 94% and features a full depth coal fuel effect. This glass fronted fire has an exceptionally large viewing area and is available in a choice of brass or silver.

Safety Features: Flame Supervision Device

Specification

Heat Input [max]	Heat Output [max]	Net Efficiency	Fuel Options		Control Options		Fire Back	Fuel Effect	Colour Options		
			Natural Gas	LPG*	Manual	EFC			Remote with Thermostat	Plain	Coal
4.6kW	4.3kW	94%	✓	✓	✓	✓	✓	✓	✓	✓	✓

\*LPG only available on manual control models

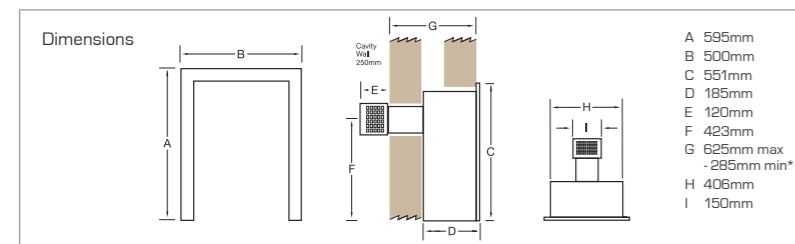

\*Differs on EFC models. An optional flue extension is available to increase maximum length to 1015mm or manual and 973mm on EFC models.



Calibre Balanced Flue in brass



Emberglow Balanced Flue



Brick Chimney



Pre-Fabricated Flue



Pre-Cast Flue

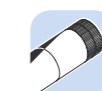

Balanced Flue

## Emberglow & Emberglow Balanced Flue

The Emberglow ultra high efficiency outlet gas fire features an elegant design with high quality cast iron canopy and fire front. With front and side windows the mesmerising dancing flames can be seen from all angles and it is operated by an easy to use electronic side control system.

Safety Features: Flame Supervision Device & Airwatch System (not applicable to balanced flue models)

Specification

Model	Heat Input [max]	Heat Output [max]	Net Efficiency	Fuel Options		Control Options			Fuel Effect
				Natural Gas	LPG	Electronic Side	Remote	Switch	Coal
Emberglow	6.0kW	4.3kW	78%	✓	✓	✓	✓	✓	✓
Emberglow BF	5.25kW	3.94kW	87%	✓	✓			✓	✓

Dimensions

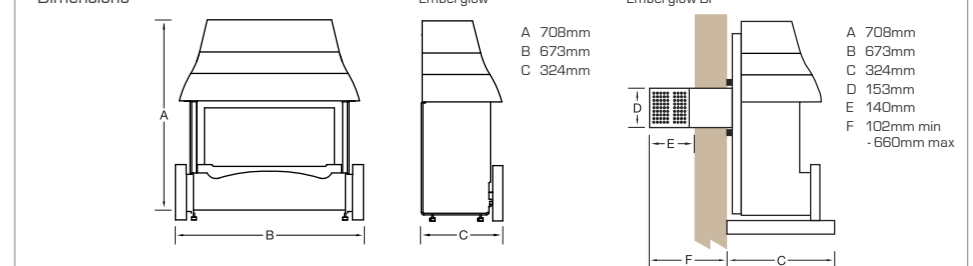



Renoir in black

Ultra High Efficiency



Regent LFE in black

Standard Efficiency



Outlet

Outlet

## Renoir



Brick Chimney



Pre-Fabricated Flue



Pre-Cast Flue



Brick Chimney



Pre-Fabricated Flue



Pre-Cast Flue

## Regent LFE

The Renoir outset living flame effect gas fire features a beautiful flickering flame effect and is operated by an electronic side control system to make it much easier to ignite the fire. This classically designed fire has an impressive heat output of 4.3kW and a net efficiency of 78%.

One of the most popular radiant fires in the UK, The Regent LFE is slim for a neat fit into an existing fireplace and is highly efficient. It provides radiant and convected heat and is an elegant interpretation of the Regency period.

Safety Features: Flame Supervision Device & Airwatch System

Specification		Control Options		Fuel Effect	Colour Options		
Heat Input (max)	Heat Output (max)	Net Efficiency	Electronic Side	Remote	Coal	Black	Bronze
6.0kW	4.3kW	78%	✓	✓	✓	✓	✓

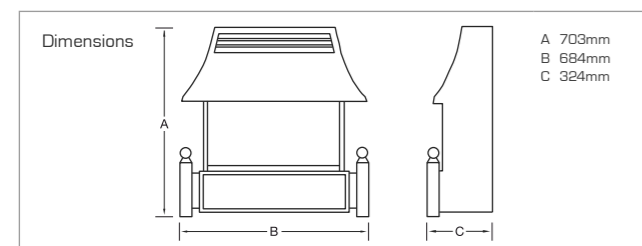

Renoir in bronze



Regent LFE in bronze

Safety Features: Flame Supervision Device & Airwatch System

Specification

Specification		Control Options		Fire Back Design	Fuel Effect	Colour Options		
Heat Input (max)	Heat Output (max)	Net Efficiency	Electronic Side	Remote	Plain	Coal	Black	Bronze
6.0kW	3.2kW	60%	✓	✓	✓	✓	✓	✓

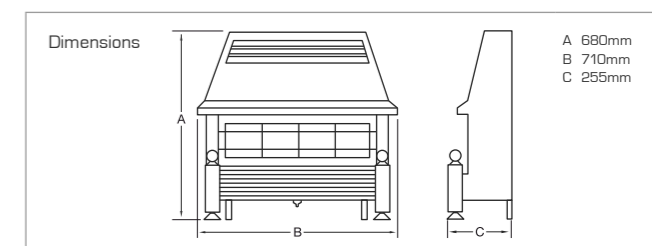



Regent in black

High Efficiency



Outlet

Welcome in bronze

High Efficiency



Outlet

## Regent



Brick Chimney



Pre-Fabricated Flue



Pre-Cast Flue



Brick Chimney



Pre-Fabricated Flue



Pre-Cast Flue

## Welcome

One of the most popular radiant fires in the UK, the Regent features a slim design and has a net efficiency of 74%. The Regent is available in a choice of black or bronze finishes and is operated by electronic side control.

The Welcome's beautiful electrically illuminated coal effect brings life to the room even when the heat is off, providing a charming focal point to any room. It is also highly efficient at 74% (net), resulting in lower running costs.

Safety Features: Flame Supervision Device & Airwatch System

Specification

Heat Input [max]	Heat Output [max]	Net Efficiency	Control Options		Colour Options	
			Electronic Side	Black	Bronze	
6.6kW	4.4kW	74%	✓	✓	✓	

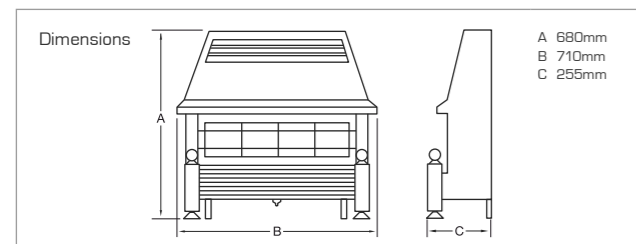

Regent in bronze



Welcome in black

Safety Features: Flame Supervision Device & Airwatch System

Specification

Heat Input [max]	Heat Output [max]	Net Efficiency	Control Options		Colour Options	
			Electronic Side	Black	Bronze	
6.6kW	4.4kW	74%	✓	✓	✓	

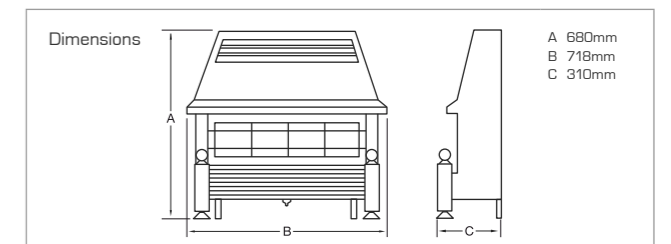



Strata in brown

Ultra High Efficiency



Misermatic in light oak

Ultra High Efficiency

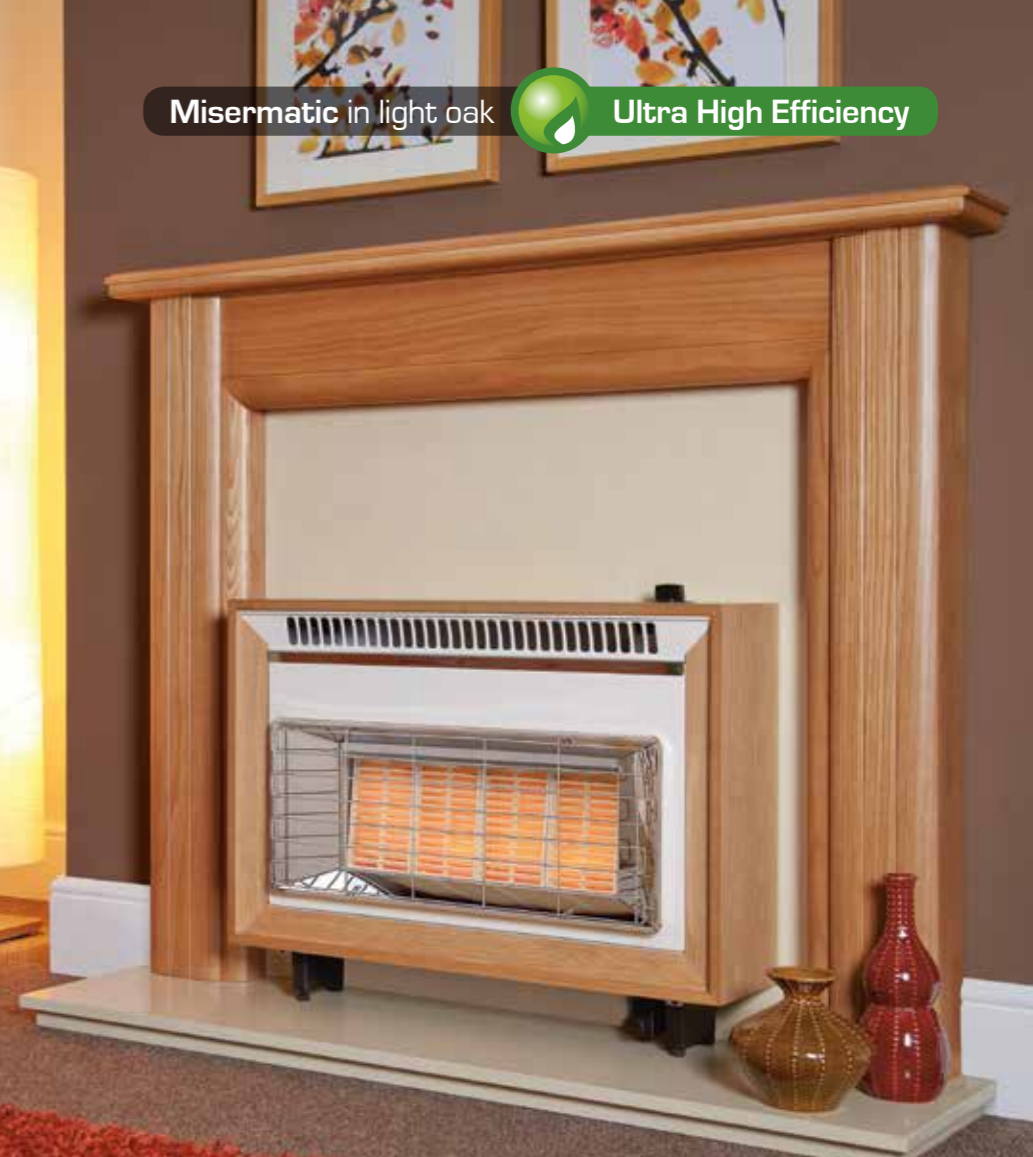

Outset

Outset

# Strata

## Gas and Electric

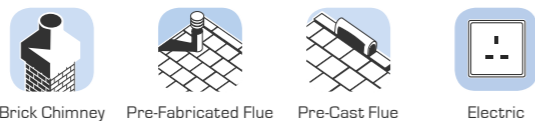

The Strata offers an incredible net efficiency of 84% and 5.2kW heat output. It has a stylish contemporary look with soft, curved lines and is available in a choice of four colour options. The Strata is also available as an electric fire, perfectly mirroring the gas radiant effect.

Safety Features (gas models only): Flame Supervision Device & Airwatch System

Model	Heat Input (max)	Heat Output (max)	Net Efficiency	Guarantee	Control Options		Colour Options			
					Electronic Top	Black	Brown	Cream	White	
Strata Gas	6.9kW	5.2kW	84%	7 years	✓	✓	✓	✓	✓	
Strata Electric	2.0kW	2.0kW		2 years	✓	✓	✓	✓	✓	

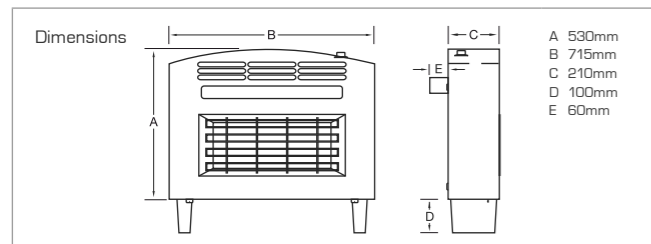

\*Only applicable to gas models.



Strata in black



Strata in white



Strata in cream



Misermatic in teak



Misermatic in medium oak



Misermatic in mahogany

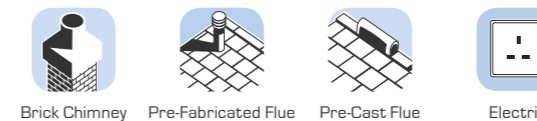

# Misermatic

## Gas and Electric

Incredible 84% net efficiency and adaptability; the Misermatic has them both. Available in a range of wood finishes, this fire can be wall or hearth mounted with an easily accessible top mounted control. The Misermatic is also available as an electric fire, perfectly mirroring the gas radiant effect.

Safety Features (gas models only): Flame Supervision Device & Airwatch System

Model	Heat Input (max)	Heat Output (max)	Net Efficiency	Guarantee	Control Options		Colour Options				
					Electronic Top	Teak	Mahogany	Light Oak	Medium Oak	Black	
Misermatic Gas	6.9kW	5.2kW	84%	7 years	✓	✓	✓	✓	✓	✓	
Misermatic Electric	2.0kW	2.0kW		2 years	✓	✓	✓	✓	✓	✓	

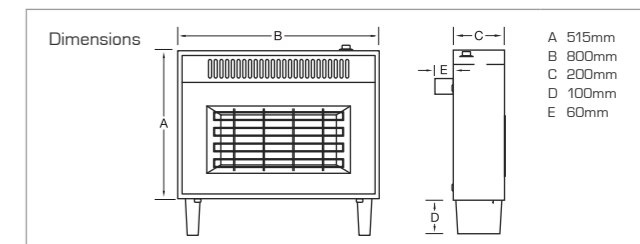

\*Only applicable to gas models.



Misermatic in black



Renaissance in silver

Ultra High Efficiency



Outset



Firenza in bronze

High Efficiency



Outset

## Renaissance Gas and Electric



Brick Chimney



Pre-Fabricated Flue



Pre-Cast Flue



Electric

The Renaissance provides a natural talking point the moment you enter the room. Its stylish retro design is matched by its forward thinking simplicity of installation, impressive 5.2kW heat output and astounding 84% net efficiency. The Renaissance is also available as an electric fire, perfectly mirroring the gas radiant effect.

Safety Features (gas models only): Flame Supervision Device & Airwatch System

Specification	Heat Input (max)	Heat Output (max)	Net Efficiency	Guarantee	Control Options		Colour Options	
					Electronic Top	Black	Silver	
Renaissance Gas	6.9kW	5.2kW	84%	7 years	✓	✓	✓	
Renaissance Electric	2.0kW	2.0kW		2 years	✓	✓	✓	

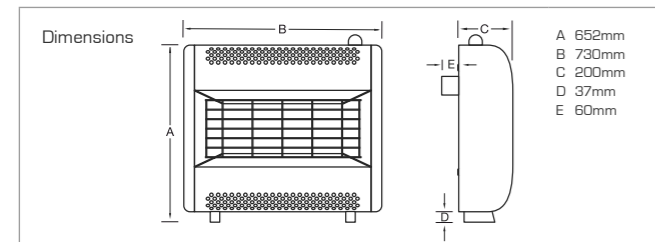

\*Only applicable to gas models.



Renaissance in black



Brick Chimney



Pre-Fabricated Flue



Pre-Cast Flue

## Firenza

The compact and economical Firenza can be wall or hearth mounted and has a net efficiency of 74%. The control handle is located on the top panel for ease of use.

Safety Features: Flame Supervision Device & Airwatch System

Specification	Heat Input (max)	Heat Output (max)	Net Efficiency	Control Options		Colour Options	
				Top Control	Black	Bronze	
Firenza	5.2kW	3.4kW	73%	✓	✓	✓	

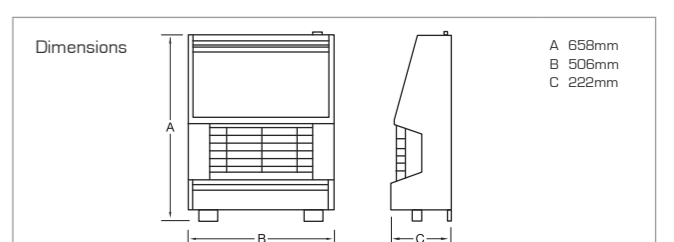

Firenza in black





# Thurcroft Stove



The Thurcroft is a 100% efficient portable stove and the ideal mobile gas appliance with a living flame effect that provides the warmth, appearance and atmosphere of a traditional stove. A self contained 7kg Butane gas cylinder\* housed within the body of the stove provides up to 60 hours burning time.

Safety Features: Flame Supervision Device & Airwatch System

Specification		Fuel Options	Control Options	Fuel Effect
Heat Input (max)	Heat Output (max)	Butane LPG	Manual	Coal
2.6kW	2.6kW	100%	✓	✓

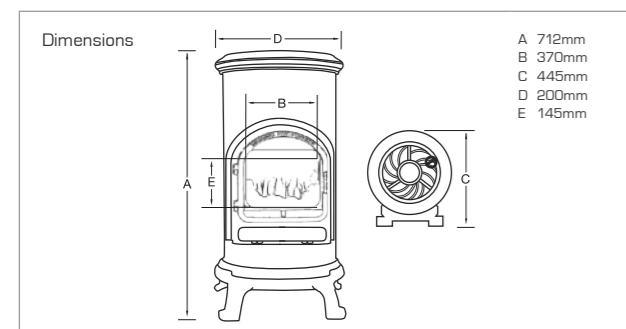

\* Not included with the appliance.  
 For details on how to obtain a Butane gas cylinder please call 0870 241 1603 or visit [www.calorgas.co.uk](http://www.calorgas.co.uk)

## Builders' Opening sizes

Product	Minimum Opening Width	Maximum Opening Width	Minimum Opening Height	Maximum Opening Height
Atlanta BF	410mm	420mm	550mm	560mm
Calibre BF	415mm	420mm	563mm	570mm
Calypso	400mm	450mm	550mm	570mm
Calypso Plus	370mm	440mm	550mm	570mm
Caress	400mm	450mm	550mm	570mm
Caress HE	400mm	450mm	550mm	570mm
Caress Plus	370mm	440mm	550mm	570mm
Caress Slimline SC	330mm	430mm	550mm	565mm
Caress Slimline MC	330mm	440mm	550mm	575mm
Castelle	350mm	400mm	490mm	500mm
Curve	300mm	440mm	300mm	440mm
Decadence HE	370mm	450mm	550mm	570mm
Decadence Plus	370mm	440mm	550mm	570mm
Decadence Slimline	330mm	440mm	550mm	575mm
Diamond HE	370mm	450mm	550mm	570mm
Emberglow	305mm	440mm	500mm	650mm
Expression HE				
Expression Plus	370mm	440mm	550mm	570mm
Finesse	330mm	430mm	550mm	575mm
Firenza	305mm	440mm	510mm	650mm
Jazz HE	650mm	660mm	460mm	470mm
Jazz BF	635mm	645mm	465mm	475mm
Kamina	300mm	440mm	300mm	440mm
Kenilworth HE	370mm	450mm	550mm	570mm
Kenilworth Plus	370mm	440mm	550mm	570mm
Kenilworth inc PF	375mm	440mm	550mm	570mm
Linear HE	370mm	450mm	550mm	570mm
Linear inc PF	375mm	440mm	550mm	570mm
Linear Plus	370mm	440mm	550mm	570mm
Melody	330mm	430mm	550mm	565mm
Misermatic	305mm	440mm	580mm	650mm
Opulence Plus	370mm	440mm	550mm	570mm
Orchestra BF	410mm	420mm	555mm	565mm
Raglan BF	410mm	420mm	555mm	565mm
Regent	305mm	440mm	470mm	650mm
Regent LFE	305mm	440mm	525mm	650mm
Renaissance	305mm	440mm	580mm	650mm
Renoir	305mm	440mm	500mm	650mm
Rhapsody	400mm	450mm	550mm	570mm
Richmond	400mm	450mm	550mm	570mm
Rocco HE	750mm	760mm	520mm	530mm
Rocco BF	730mm	780mm	540mm	550mm
Sophia	760mm	790mm	870mm	880mm
Stirling Plus	330mm	440mm	550mm	575mm
Strata	305mm	440mm	580mm	650mm
Warwick inc PF	330mm	430mm	550mm	565mm
Waverley*	400mm	440mm	550mm	575mm
Waverley**	560mm	600mm	690mm	720mm
Welcome	305mm	440mm	470mm	650mm
Windsor	330mm	440mm	550mm	575mm
Windsor HE	330mm	440mm	550mm	575mm
Windsor Plus	330mm	440mm	550mm	575mm

\*when fitted into standard builders opening with existing chair-brick  
 \*\*when fitted with "Victorian" style casting





[www.flavelfires.co.uk](http://www.flavelfires.co.uk)

Go direct to the Flavel website on your smart phone or tablet device, just scan in this QR code.

**WARNING** BFM Europe Limited is a Gas Safe Register company. We recommend that all of our fires are installed by Gas Safe Register engineers in accordance with our instructions, electric models by a competent person.

**DISCLAIMER** Our policy is one of constant development and improvement. We therefore reserve the right to revise designs and specifications of our products without formal notice, patents pending. We always recommend our products be viewed in an approved showroom before purchase.

Whilst we have taken every care in the preparation of this brochure it is not intended to replace the installation manual which provides more detailed information.

Photography is for illustration purposes only and although every effort has been made to ensure accurate reproduction of typical installations and flame pictures they may vary according to fire model and flue types.

We accept no liability for any loss or damage arising directly or indirectly from the use of this brochure.

We recommend that all our fires are used in conjunction with central heating and not as a primary source of heat.

In the interests of personal safety a suitable fireguard is recommended when children, the elderly and the infirm are present.

(This brochure is copyright 2015 and must not be reproduced in whole or in any part without prior written permission).

We would like to thank Kedleston Heating [01332 200303], Olde England Reproductions [01782 319350], Stanningley Firesides [0113 257 1512] and GB Mantles [01924 473243] for contributing fire surrounds to this brochure.



**MADE  
IN BRITAIN**



Find us on Facebook,  
Twitter, Pinterest & YouTube



At the heart of your home

BFM Europe Limited, Trentham Lakes, Stoke-on-Trent, Staffordshire ST4 4TJ.

Tel: 01782 339000. [www.flavelfires.co.uk](http://www.flavelfires.co.uk) e-mail: [info@bfm-europe.com](mailto:info@bfm-europe.com)

Issue No. 33